

Article number: 01020771

Description: Retaining ring J62 DIN472  
Stainless 411

## Measures

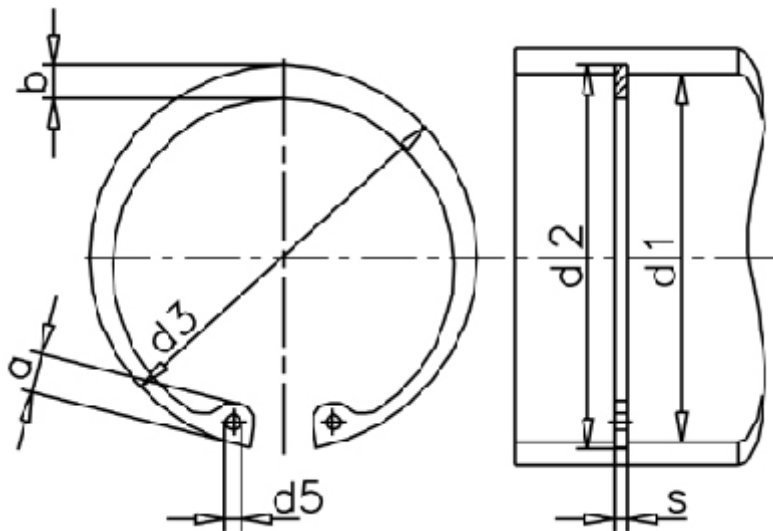

a max	= 7.3	FN kN	= 49.80	t	= 1.50
AN mm <sup>2</sup>	= 299.0	FRg kN	= 13.0	tol	= +0,30
b	= 5.5	FR kN	= 60.9	tol	= +1,10-0,46
d1	= 62	g	= 2.0	tol	= -0.07
d2	= 65.0	K kN-mm	= 112.0	Tong	= ZGJ-3
d3	= 66.20	m min	= 2.15	Weight kg/1000	= 11.20
d5 min	= 2.5	Nominal drive	= 4.5		
Description = J 62		s	= 2.00		